

Dealer \_\_\_\_\_

## Key

standard

option

# VENUS

- L** Seat width 34 36 38 40 42 44 46  
**P** Seat depth 36 38 40 42 44  
**HS** Back-rest height 27 29 31 33 35 37 39  
**HA** Front seat/floor height 46 48 50  
**HP** Rear seat/floor height 39 41 43 45 47  
**DP** Foot-rest/seat distance 31 33 35 37 39 41 43 45 47 49

cm

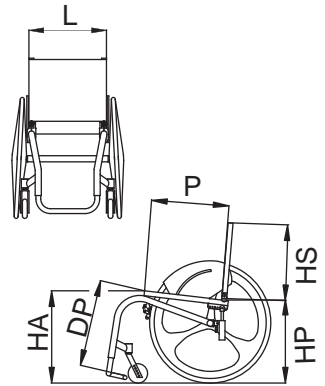

### Frame colour

- Shiny titanium  Pearl white  Glossy black  Matt black

Natural titanium

..... (see "Colours" catalogue)

### Upholstery

Tension adjustable nylon back-rest

Tension adj. breathable back-rest

Without back-rest

### Single tubular foot-plate

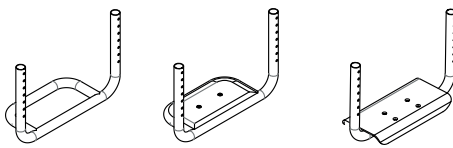

Open

Carbon fibre closed

Tilt adjustable Carbon fibre closed

### Pushing handles

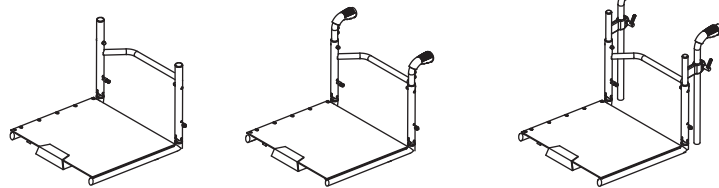

Without pushing handles  Standard pushing handles  Height adjustable pushing handles

### Distance between the hub centre and back-rest

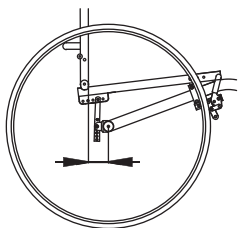

- 4 cm  
 5 cm  
 7 cm (standard)  
 9 cm  
 11 cm

### Back-rest tilt

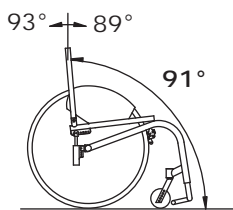

89°  91° (standard)  93°

### Seat with shock absorbers

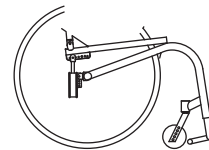

User weight : ..... kg

It is not possible to have two anti-tip devices

### Side guards



Aluminium with fixed carbon fibre wing

Straight aluminium

Aluminium with detachable carbon fibre wing

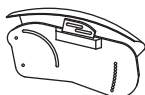

### Detachable "L" arm-rest - h 22 cm

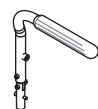

Tip-up

**Elbow-rest**

- Tubular  
 Straight (26 cm long)  
 Classic (23 cm long)  
 Classic (30 cm long)

### Brakes

Push brake (std)

Pull brake

Scissor brake



### Revolving anti-tip device

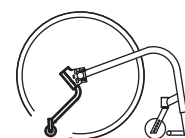

Right

Left

### Notes





Order N° \_\_\_\_\_  Quotation  
 Date \_\_\_\_\_ Signature \_\_\_\_\_  
 Customer Ref. \_\_\_\_\_

PAGE 2/2  
 2016 validity

VENUS

Dealer \_\_\_\_\_

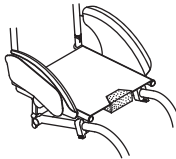
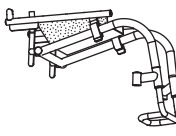
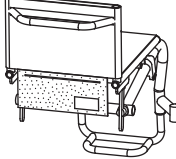
<p><b>Rear wheels</b> (12)</p> <p><input type="checkbox"/> 24" Light (24 spokes)  <input type="checkbox"/> 24" Star 6x3 (18 spokes)  <input type="checkbox"/> 24" (36 spokes)  <input type="checkbox"/> 24" Mountain-bike w/Citybike tyres  <input type="checkbox"/> 24" Mountain-bike w/Offroad tyres  <input type="radio"/> 24" Ultralight (24 spokes) black  <input type="radio"/> 24" Spinerger  <input type="radio"/> 25" Spinerger  <input type="radio"/> 25" Light (24 spokes) black</p> <p><b>Tyres</b></p> <p><input type="checkbox"/> Pneum. Light Run  <input type="checkbox"/> Pneum. Marathon Plus  <input type="checkbox"/> Pneum. high press. smooth  <input type="checkbox"/> Pneum. high press. plugged  <input type="radio"/> Solid 24"</p>	<p><b>Handrims</b> (13)</p> <p><input type="checkbox"/> Aluminium silver  <input type="checkbox"/> Aluminium dark  <input type="checkbox"/> Chrome plated steel 24"  <input type="radio"/> Titanium  <input type="radio"/> Rubber coated  <input type="radio"/> Tween Grepp 24"  <input type="radio"/> Max Grepp 24"  <input type="radio"/> Max Grepp Ergo 24" (**)  <input type="radio"/> Silicon cover 24"</p> <p style="font-size: small;">(**) not suitable for wheels Star 6x3 and Mountain bike</p>	<p><b>Spoke guards</b> (14)</p> <p><input type="radio"/> Transparent  <input type="radio"/> White  <input type="radio"/> Black  <input type="radio"/> Multicolour  <input type="radio"/> Black plumed red  <input type="radio"/> Black plumed blue  <input type="radio"/> Black plumed green  <input type="radio"/> Alphabet</p> <p><b>Rear wheel camber</b> (15)</p> <p><input type="checkbox"/> 1°          <input type="checkbox"/> 2°  <input type="checkbox"/> 3°          <input type="checkbox"/> 4°</p>	<p><b>Front castors</b> (16)</p> <p><input type="checkbox"/> 80 (3") solid  <input type="radio"/> 80 (3") solid with lights  <input type="checkbox"/> 100 (4"x1.1/4) solid with plastic rim  <input type="radio"/> 100 (4"x1) solid with lights  <input type="checkbox"/> 100 (4"x1) solid with aluminium rim  <input type="checkbox"/> 100 (4"x1.1/4) solid with aluminium rim  <input type="checkbox"/> 125 (5"x1.1/4) solid with plastic rim  <input type="checkbox"/> 125 (5"x1) solid with aluminium rim  <input type="checkbox"/> 125 (5"x1.1/4) solid with aluminium rim</p>
---	---	---	---

<p><b>Pockets</b> (17)</p>  <p><input type="checkbox"/> Small under the seat</p>  <p><input type="radio"/> Big under the seat</p>  <p><input type="checkbox"/> On the back-rest</p>	<p><b>Lined cushion</b> (18)  in foam polyurethane</p>  <p><input type="radio"/> 3 cm high _____  <input type="radio"/> 5 cm high _____</p> <p><b>Anodized set</b> (19)  <i>(Rear wheel rims, rear wheel hubs, forks)</i></p> <p><input type="checkbox"/> Silver  <input type="checkbox"/> Black  <input type="radio"/> Lime Green  <input type="radio"/> Light blue  <input type="radio"/> Red  <input type="radio"/> Orange  <input type="radio"/> Cyclamen light purple</p> <p style="font-size: small;">(only Light wheels)</p>	<p><b>Options</b></p> <p>20 <input type="checkbox"/> "M" velcro strip (hook) on seat  21 <input type="checkbox"/> "F" velcro strip (loop) on seat  22 <input type="radio"/> Padded rigid seat h 5  23 <input type="radio"/> Chest harness  24 <input type="radio"/> Chest belt  25 <input type="radio"/> Abductor belt  26 <input type="radio"/> Catheter holder pocket  27 <input type="radio"/> Rx <input type="radio"/> Lx Crutch holder  28 <input type="radio"/> Pump for pneumatics  29 <input type="radio"/> Suitcase holder  30 <input type="radio"/> 45° pelvic belt  31 <input type="radio"/> 45° padded pelvic belt  32 <input type="radio"/> Black holdall  34 <input type="radio"/> Umbrella holder  35 <input type="radio"/> Front protective covers</p>
---	--	--

**Notes**

---

---

---

---

---

---

---

---

---

---

---

---

Mod. OFVENS7-EN Send to: OFF CARR S.R.L. Via Dell'Artigianato II, 29 - 35010 Villa del Conte (Padova) Italy Tel: +39 049 9325733 Fax: +39 049 9325734 e-mail: offcarr@offcarr.com - www.offcarr.com