

Order N° _____ Quotation
 Date _____ Signature _____
 Customer Ref. _____

PAGE 1/2
 2020, January

Dealer

Key standard option

HALLEY

L Seat width	<input type="checkbox"/> 34 <input type="checkbox"/> 36 <input type="checkbox"/> 38 <input type="checkbox"/> 40 <input type="checkbox"/> 42 <input type="checkbox"/> 44	
P Seat depth	<input type="checkbox"/> 36 <input type="checkbox"/> 38 <input checked="" type="checkbox"/> 40 <input type="checkbox"/> 42 <input type="checkbox"/> 44	
HS Back-rest height	<input type="checkbox"/> 29 <input type="checkbox"/> 31 <input type="checkbox"/> 33 <input type="checkbox"/> 35 <input type="checkbox"/> 37 <input type="checkbox"/> 39 <input type="checkbox"/> 41	
HA Front seat/floor height	<input type="checkbox"/> 46 <input type="checkbox"/> 48 <input checked="" type="checkbox"/> 50	
HP Rear seat/floor height	<input type="checkbox"/> 40 <input type="checkbox"/> 42 <input checked="" type="checkbox"/> 44 <input type="checkbox"/> 46	
DP Foot-rest/seat distance	<input type="checkbox"/> 35 <input type="checkbox"/> 37 <input type="checkbox"/> 39 <input type="checkbox"/> 41 <input type="checkbox"/> 43 <input type="checkbox"/> 45 <input type="checkbox"/> 47	cm

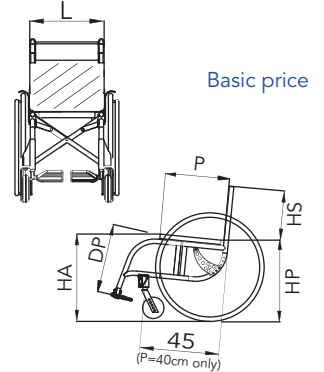

- Frame colour**
- Glossy black
 - Pearl white
 - Neon orange
 - Pearl red
 - Metallic blue
 - Neon green
 - Metallic light blue
 - Metallic grey
 - (see "Colours" catalogue)

- Upholstery**
- Tension adjustable nylon back-rest
 - Tens.adjustable breathable backrest
 - Without backrest
 - FAMEKH** custom postural backrest (fill up the proper order form)

- Upholstery colour** (nylon only)
- Black
 - Red
 - Light blue
 - Cornflower blue
 - Orange
 - Green

- Not detachable foot-rest** (with DP=43 cm and P=40 cm) (standard) ④

 Not detachable foot-rest (with DP=43 cm and P=40 cm)

 Detachable foot-rest

- Closed carbon single foot-plate** ⑥

 Foot-holding belts

- Automatic closure foot-plate in carbon** ⑦

 Foot-holding belts

- Separate aluminium profile tilt adjustable foot-plates** ⑧
 forward backward

 Foot-holding belts

- Single aluminium profile tilt adjustable foot-plate** ⑨
 forward backward

 up & outward
 Foot-holding belts

- Side guards** ⑩
 Carbon fibre

 Aluminium

- Detachable sport arm-rest h. 22 cm** ⑪

 Tip-up
Elbow-rest
 Tubular
 Classic (23 cm long)
 Classic (30 cm long)

- Tip-up height adjustable from 22 to 28 cm "L" arm-rest** (open with sideguards) ⑫

Elbow-rest
 Tubular
 Straight (26 cm long)
 Classic (23 cm long)
 Classic (30 cm long)

- Rear wheels** ⑬
 24" Star 6x3 (18 spokes)
 24" (36 spokes)
 24" Light(24 spokes)
 24" MTB with Citybike tyre
 24" MTB with Offroad tyre
 24" Spinergy
 24" Ultralight(24 spokes)
Tyres
 Pneumatic Marathon Plus
 Pneum. high press. plugged
 Pneum. high press. smooth
 Solid (not avail. with Ultralight)

- Aluminium silver
 Aluminium dark
 Chromium-plated steel 24"
 Rubber coated
 Titanium
 Carbolife CURVE L24**
 CL Curve L TetraGrip 24**
 CL Quadro 24**
 Carbolife GEKKO 24**
 Silicon covers

* not suitable for wheels Star 6x3 and Mountain Bike

Order N° _____ Quotation
 Date _____ Signature _____
 Customer _____

PAGE 2/2
 2020, January

HALLEY

Dealer

Spoke guards 15

- Transparent
- Black
- Alphabet
- Fantasy
 code pattern:
 (see spokes guards catalogue)

Front castors 16

- 100 (4"x1.1/4) solid with plastic rim
- 100 (4"x1) solid with lights
- 100 (4"x1.1/4) solid with alum. rim
- 125 (5"x1.1/4) solid with plastic rim
- 125 (5"x1.1/4) solid with alum. rim
- 125 (5"x1) solid with lights
- 150 (6") pneumatic
- 150 (6") solid

Revolving anti-tip device 17

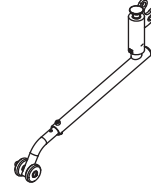

- Right
- Left

Back-rest pushing handles 18



- Standard 
- Hinged back-rest
 (without stretched bar HS>37)
 (with stretched bar HS>41) 
- Height adjustable 

Table 19

- Transparent
 - Plastic grey
 - Soft padded
- Specify the fastening:
 single double
- 
- (only with arm-rest)

Anodized set 20

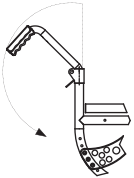
- (Rear wheel rims and hub, forks)
- Black
 - Silver
 - Light blue
 - Red
 - Orange
 - Cyclamen light purple
- (only Light wheels)

**Lined cushion
 in foam poliurethane** 21

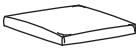
- 
- 3 cm high
 - 5 cm high

Options

- 23 "M" velcro strip (hook) on seat
- 24 "F" velcro strip (loop) on seat
- 25 Seat/back-rest connection flap
- 26 Padded rigid seat h 5
- 27 Chest harness
- 28 Chest belt
- 29 Abductor belt
- 30 Catheter holder pocket
- 31 Stretched bar

Options

- 32 Back-rest anatomic board
- 33 Rx Lx Crutch holder
- 34 Pump for pneumatics
- 35 Suitcase holder
- 36 45° pelvic belt
- 37 45° padded pelvic belt
- 38 Black backpack
- 40 Umbrella holder

Brakes 22

- Classic - short handle
- Classic - pull to brake short handle
- Classic - long handle
- Scissor

Notes
