

Dealer \_\_\_\_\_

**Key**       standard       option

# EUROPA

<b>L</b> Seat width	<input type="checkbox"/> 38 <input type="checkbox"/> 40 <input type="checkbox"/> 42 <input type="checkbox"/> 44 <input type="radio"/> 46 <input type="radio"/> 48 <input type="radio"/> 50
<b>P</b> Seat depth	<input type="checkbox"/> 38 <input checked="" type="checkbox"/> 40 <input type="checkbox"/> 42 <input type="checkbox"/> 44
<b>HS</b> Back-rest height	<input type="checkbox"/> 37 <input type="checkbox"/> 39 <input type="checkbox"/> 41 <input type="checkbox"/> 43
<b>HA</b> Front seat/floor height	<input type="checkbox"/> 48 <input checked="" type="checkbox"/> 50 <input type="checkbox"/> 52
<b>HP</b> Rear seat/floor height	<input type="checkbox"/> 45 <input checked="" type="checkbox"/> 47 <input type="checkbox"/> 50
<b>DP</b> Foot-rest/seat distance	<input type="checkbox"/> 37 <input type="checkbox"/> 39 <input type="checkbox"/> 41 <input type="checkbox"/> 43 <input type="checkbox"/> 45 <input type="checkbox"/> 47 <input type="checkbox"/> 49 cm

**Quantity**

Nr. .... pieces

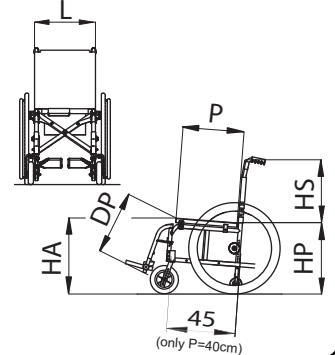

**Frame colour** ①

- Metallic blue
- Metallic grey

**Upholstery** ②

- Nylon
- Tension adj. nylon back-rest
- Tension adj. breathable back-rest
- Without back-rest
- Without seat

**Detachable foot-rests with plastic foot-plates and heel stops** ③

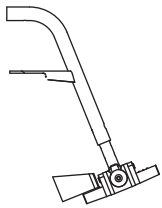

- Foot-holding belts

**Elevating detachable foot-rests with plastic foot-plates and heel stops** ④ (only P = 38 or 40 cm)

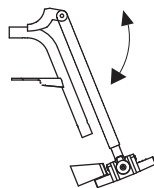

- Foot-holding belts

**Single drive** ⑤

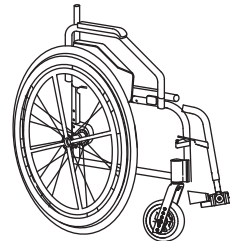

- Right
- Left

**Features**

- Aluminium folding frame;
- Aluminium double cross bar;
- Nylon fireproof upholstery;
- Quick-release rear wheels;
- Tilt adjustable foot-plates;
- Heel stops;
- Adjustable rear wheel plate;
- Tilt adjustable front fork plate;
- Height adjustable back-rest;
- Unbalancing pedals;
- Weight w40xd40hx37 cm : 15,9 kg.

**Detachable desk tip-up arm-rest h 22 cm** ⑥

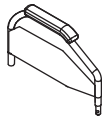

- Closed
- Open with side guards

**Elbow-rest**

- Classic (23 cm long)
- Straight (26 cm long)
- Hemiplegic RX
- Hemiplegic LX

**Detachable "U" tip-up arm-rest h 22 cm** ⑦

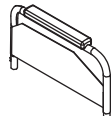

- Closed
- Open with side guards

**Elbow-rest**

- Straight (26 cm long)
- Straight (36 cm long)
- Hemiplegic RX
- Hemiplegic LX

**Detachable height adjustable tip-up arm-rest** ⑧ (only closed)

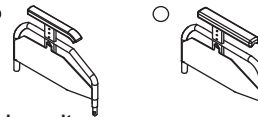

**Appoggiagomito**

- Classic (23 cm long)
- Classic (30 cm long)
- Straight (26 cm long)
- Straight (36 cm long)
- Hemiplegic RX
- Hemiplegic LX

**Rear wheels** ⑨

- 24"
- 22"
- 20"

**Tyres**

- Pneumatic plugged
- Solid

**Handrims** ⑩

- Aluminium silver
- Rubber coated
- Steering (\*)
- Tween Greep (\*)
- Max Grepp
- Max Grepp Ergo
- Silicon covers

(\*) only for 24" and 22" wheels

**Spoke guards** ⑪

- Transparent
- White
- Black
- Multicolour
- Black plumed red
- Black plumed blue
- Black plumed green
- Alphabet

**Front castors** ⑫

- 150 (6"x1.3/8) solid
- 150 (6"x1.1/4) pneum.
- 175 (7"x1) solid
- 175 (7"x1.3/4) pneum.
- 175 (7"x1.3/4) solid

**Options**

- 17  "M" velcro strip (hook) on seat
- 18  "F" velcro strip (loop) on seat
- 19  Seat/back-rest connecting flap
- 20  WC seat
- 21  Padded rigid seat
- 22  Chest harness
- 23  Chest belt
- 24  Abductor belt
- 25  Catheter holder pocket
- 26  Hinged back-rest
- 27  Back anatomic board
- 28  Rx  Lx Crutch holder
- 29  Pump for pneumatics
- 30  45° pelvic belt
- 31  45° padded pelvic belt
- 32  Black holdall
- 33  Holdall with bottle holder
- 34  Umbrella holder
- 35  Lined cushion, h 3cm high
- 36  Lined cushion, h 5cm high

**Extended wheel plate** ⑬ (only HP=47 or 50 cm)

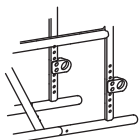
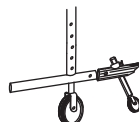

**Table** ⑭ (only with arm-rest)

- Transparent
- Plastic grey
- Soft padded

Specify the fastening:  
 Single     Double  
 (the double fastening is compulsory with height adjustable arm-rests)

**Anti-tip device** ⑮ (only HP=47 or 50 cm)



- 
- 

**Small wheels for narrow passages** ⑯

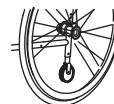

- Without small wheels for narrow passages

Notes \_\_\_\_\_