

Dealer _____

Key

standard

option

MIZAR

L Seat width	<input type="checkbox"/> 40 <input type="checkbox"/> 42 <input type="checkbox"/> 44 <input type="checkbox"/> 46 <input type="checkbox"/> 48
P Seat depth	<input type="checkbox"/> 38 <input checked="" type="checkbox"/> 40 <input type="checkbox"/> 42 <input type="checkbox"/> 44
HS Back-rest height	<input type="checkbox"/> 37 <input type="checkbox"/> 39 <input type="checkbox"/> 41 <input type="checkbox"/> 43
HA Front seat/floor height	50
HP Rear seat/floor height	47
DP Foot-rest/seat distance	<input type="checkbox"/> 37 <input type="checkbox"/> 39 <input type="checkbox"/> 41 <input type="checkbox"/> 43 <input type="checkbox"/> 45 <input type="checkbox"/> 47 <input type="checkbox"/> 49 cm

Quantity

Nr. pieces

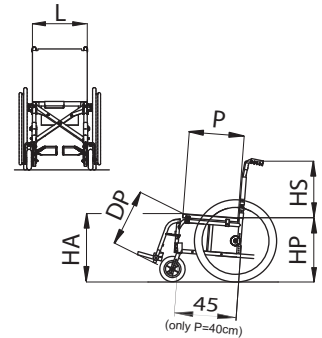

Frame colour

- Metallic blue
- Metallic grey

①

Upholstery

- Nylon
- Tension adj. nylon back-rest
- Tension adj. breathable back-rest

②

- Without back-rest
- Without seat

Detachable foot-rests with plastic foot-plates and heel stops

③

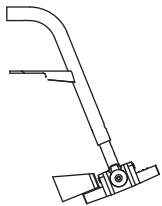

- Foot-holding belts

Elevating detachable foot-rests with plastic foot-plates and heel stops
(only P = 38 or 40 cm)

④

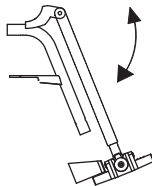

- Foot-holding belts

Anti-tip device

⑤

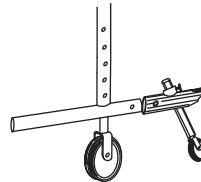

- Right
- Left

Features

- Aluminium folding frame;
- Steel single cross bar;
- Nylon fireproof upholstery;
- Tilt adjustable foot-plates;
- Heel stops;
- Height adjustable arm-rests;
- Unbalancing pedal;
- Weight
w40xd40hx37 cm: 15,6 kg.

Detachable desk tip-up arm-rest - h 22 cm

⑥

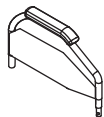

Elbow-rest

- Classic
- Hemiplegic RX
- Hemiplegic LX

Detachable "U" tip-up arm-rest h 22 cm

⑦

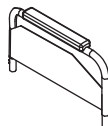

Elbow-rest

- Straight (26 cm long)
- Straight (36 cm long)
- Hemiplegic RX
- Hemiplegic LX

Detachable height adjustable tip-up arm-rest

⑧

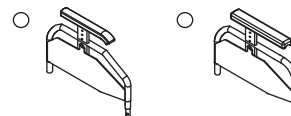

Elbow-rest

- Classic (23 cm long)
- Classic (30 cm long)
- Straight (26 cm long)
- Straight (36 cm long)
- Hemiplegic RX
- Hemiplegic LX

Rear wheels

⑨

- 24"
- 12"

Tyres

- Pneumatic plugged
- Solid

Handrims

⑩

- Aluminium silver
- Rubber coated
- Steering
- Tween Greep
- Max Grepp
- Max Grepp Ergo
- Silicon covers

Not available with 12" wheels

Table

⑪

- Transparent
- Plastic grey
- Soft padded

Specify the fastening

- Single Double

(the double fastening is compulsory with height adjustable arm-rests)

Options

- 15 "M" velcro strip (hook) on seat
- 16 "F" velcro strip (loop) on seat
- 17 Seat/back-rest connection flap
- 18 WC seat
- 19 Padded rigid seat
- 20 Chest harness
- 21 Chest belt
- 22 Abductor belt
- 23 Catheter holder pocket
- 24 Hinged back-rest
- 25 Back anatomic board
- 26 Rx Lx Crutch holder
- 27 Pump for pneumatics
- 28 45° pelvic belt
- 29 45° padded pelvic belt
- 30 Black holdall
- 31 Holdall with bottle holder
- 32 Umbrella holder
- 33 Lined cushion, h 3cm high
- 34 Lined cushion, h 5cm high

Front castors

⑫

- 175 (7"x1) solid
- 175 (7"x1.3/4) solid
- 175 (7"x1.3/4) pneumatic

Spoke guards

⑬

- Transparent
- White
- Black
- Multicolour
- Black plumed red
- Black plumed blue
- Black plumed green
- Alphabet

Not available with 12" wheels

Quick-release mechanism for rear wheels

⑭

- Quick-release kit **without** small wheels for narrow passages for 24" wheels
- Quick-release kit **with** small wheels for narrow passages for 24" wheels

Note _____