

Key
 standard
 option

PAG. 1/2
 May 2024

Dealer _____

L Seat width (adjustable)
 RANGE 1..... 26 28 30 32 34 36
 RANGE 2..... 30 32 34 36 38 40 42 44 46
 RANGE 3..... 40 42 44 46 48 50 52

VEGA 3000
 Width & depth adjust.
 fold.alum.frame

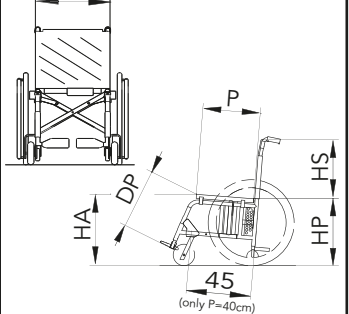

P Seat depth 38 40 42 44 (adjustable from 38 to 44 cm)
 40 42 44 46 (adjustable from 40 to 46 cm)
 42 44 46 48 (adjustable from 42 to 48 cm)
 44 46 48 50 (adjustable from 44 to 50 cm)
HS Back-rest height 29 31 33 35 37 39 41
 HS adjustable from 29 to 37 cm 35 to 43 cm (frame & upholstery)
HA Front seat/floor height 42 43 44 46 48 50
 Possible front castors HA 42:4" HA43/44:4"/5" HA46/48:4"/5"/6" HA50:4"/5"/6"/7" HA 52:6"/7" HA54:7"
HP Rear seat/floor height 38 40 42 44 46 48
 Possible rear wheels HP 38:20"/22" HP40/42:20"/22"/24" HP44/46:22"/24" HP48/50:24" only
DP Foot-rest/seat distance 33 35 37 39 41 43 45 47 cm
 DP 19/21/23: only not detachable footrests & internally assembling of footplate DP 25/27/29/31: internally assembling of footplate

Frame colour

Glossy black Pearl red Deep sky light blue
 Pearl white Metallic blue Metallic grey
 (see "Colours" catalogue) from:
 Neon orange Neon green

Upholstery

Tension adjustable nylon back-rest
 Tens.adjustable breathable backrest
 Without any backrest upholstery
 AMEKH custom postural backrest (fill up the proper order form)

Upholstery colour (nylon only)

Black
 Red Orange
 Light blue Green
 Cornflower blue

4 Not detachable foot-rest
 Detachable foot-rest
 Elevating foot-rest (detachable)

5 **Separate aluminium profile tilt adjustable foot-plates:**

forward
 backward
 Foot-holding belts

7 Plastic separate (only DP > 35 cm and L = from 38 to 46 cm)

Foot-holding belts
 Heel stops

8 Reclining backrest

Note:
 1) subject to technical approval
 2) compulsory:
 - extended wheel plate
 - stretched bar

10 **Single aluminium profile tilt adjustable foot-plate:** (not available with detachable foot-rest)

forward
 backward
 Foot-holding belts

Up & outward

11 Height adjustable arm-rest (only with aluminium side guards) (only L from 34 to 44 cm)

Elbow-rest

Classic (23 cm long)
 Classic (30 cm long)
 Straight (26 cm long)

12 **Side guards** (not suitable with reclining backrest)

Plastic
 Aluminium
 Carbon fibre
 Plastic round cover

13 Detachable Desk arm-rest - h 22 cm

Open with side guards (only with HP > 42 cm)
 Closed
 27 cm high from the seat
 Tip-up (not for reclining backrest)

Elbow-rest

Classic (23 cm long)
 Straight (26 cm long)
 Tubular (only with open arm-rest)
 Hemiplegic RX
 Hemiplegic LX
 note: see also Hemi modular armrest ord.form

14 Tip-up height adjustable from 22 to 28 cm "L" arm-rest (not detachable, open with sideguards not suitable with reclining backrest)

Elbow-rest

Tubular
 Straight (26 cm long)
 Classic (23 cm long)
 Classic (30 cm long)

15 Detachable "U" arm-rest - h 22 cm

Open with side guards (only with HP > 42 cm)
 Closed
 Tip-up (not for reclining backrest)

Elbow-rest

Straight (26 cm long)
 Straight (36 cm long)
 Tubular (only with open arm-rest)
 Hemiplegic RX
 Hemiplegic LX
 note: see also Hemi mod.armrest ord.form

16 Height adjustable arm-rest (only closed)

Desk model
 "U" model

Elbow-rest

Classic (30 cm long)
 Straight (26 cm long)
 Hemiplegic RX
 Hemiplegic LX
 note: see also Hemi modular armrest ord.form

Dealer _____

Rear wheels (17)

- 24" (36 spokes)
- 24" Star 6x3(18sp.)
- 22" (36 spokes)
- 24" Light (24 spokes)
- 20" (36 spokes)
- 24" Mountain-bike with Citybike tyre
- 24" Mountain-bike with Offroad tyre
- 24" Ultralight (24 spks) black
- 24" Spinerly LX

Tyres

- Pneumatic Marathon Plus
- Pneum. high pressure Plugged
- Pneum. high pressure Smooth
- Solid grey 20"/22"/x1 or 1.3/8"
- Solid black KIK 24"x1

Pushrim s (18)

- Aluminium silver
 - Aluminium dark
 - Chromium-plated steel 24"
 - Rubber coated
 - Carbolife CURVE L 24"(*)
 - OVAAL silver alum. (*)
 - OVAALS dark alum. (*)
 - OVAALG dark w/sil. insert (*)
 - Carbolife GEKKO 24" (*)
 - Silicon covers 24"
- (*) not available with MTB wheels

Spoke guards (19)

- Transparent 24"
 - Black 24"
 - Fantasy
- code pattern
- (see catalogue of spokeguards)

Front castors (20)

- 100 (4"x1.1/4) solid with plastic rim
- 100 (4"x1) solid with lights
- 100 (4"x1.1/4) solid with alum. rim
- 125 (5"x1.1/4) solid with plastic rim
- 125 (5"x1.1/4) solid with alum. rim
- 125 (5"x1) solid with lights
- 150 (6") pneumatic
- 150 (6") solid
- 175 (7") solid
- 175 (7") pneumatic

Rear frame (21)

- STRAIGHT rear frame with small wheels for narrow passages (default)

- camber
- 0°
 - 1°
 - 2°
 - 3°

- STRAIGHT rear frame WITHOUT any small wheels for narrow passages

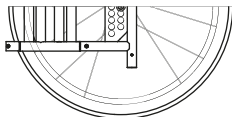
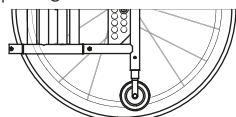

- STRAIGHT rear frame with LEVER-activated narrow passage wheels € 134,00

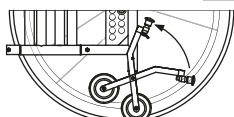

(Compulsory: rear seat/floor height HP= from 44 to 48 cm)

Curved rear frame

- without camber
- with camber

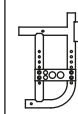
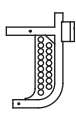

- 0°
- 1°
- 2°
- 3°

(it is not possible to assemble any small wheels for narrow passages)

Unbalancing system (22)

- Right
 - Left
- (Only with curved rear frame)

Anti-tip device

- Right
- Left

Revolving anti-tip device

(Only with curved rear frame)

- Right
- Left

Single drive (23)

- Right
- Left



(camber can be only 0° (rear wheels can be only 22" or 24") (the axle can grow +2cm or +4cm)

Extended wheel plate (24)

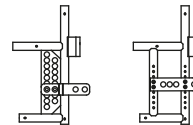

(compulsory with reclining backrest)

Pushing handles (25)

- Standard
- Hinged back-rest (*) (no stretched bar) (not for reclining backrest)

- Height adjustable (*)

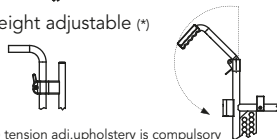

(*) tension adj. upholstery is compulsory

Abductor (26)

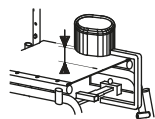

- 01
- 03
- 05
- 07 cm
- cm

Choose or specify the height from seat cover

Lateral supports (27)

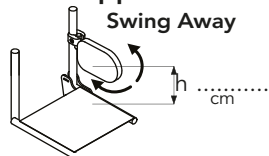

- Right
- Left

Specify the height "h" tension adj. upholstery is compulsory

Table (28)

- Transparent
 - Plastic grey
 - Soft padded
 - RXOSX Hemiplegic transparent
- specify the fastening:
- single
 - double

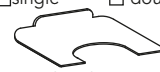

(Only with arm-rest) OXL if L>50cm

Head-rest (29)

Padded

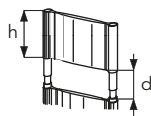

- Fixed
- Height adjustable

Orbital

- Anatomic

- Moulded

- With lateral supports

Specify "h" & "d" where requested
 Standard: h = 20 cm d = 15 cm
 h = cm d = cm

Lined cushion (30)

in foam polyurethane



- 3 cm high
- 5 cm high

Anodized set (32)

(Rear wheel rims and hubs, forks)

- Black
- Silver
- Light blue
- Red
- Orange
- Cyclamen light purple

(Only LIGHT 24" wheels)

Brakes (31)

- Classic - short handle
 - Classic - pull to brake short handle
 - Classic - long handle
 - Scissor
 - Right single drive
 - Left single drive
 - Drum
 - Drum + classic
- Some combinations may require technical evaluation

Options

- 33 "M" velcro strip (hook) on seat
- 34 "F" velcro strip (loop) on seat
- 35 Seat/back-rest connection flap
- 36 Padded rigid cushion h 5
- 37 Chest harness
- 38 Chest belt
- 39 Front protective covers

Options

- 40 Abductor belt
- 41 Catheter holder pocket
- 42 Stretched bar
- 43 Rx Lx Crutch holder
- 44 Rx Lx Double Crutch holder
- 45 Pump for pneumatics
- 46 Suitcase holder
- 47 45° pelvic belt
- 48 45° padded pelvic belt
- 49 Black backpack

Notes

