

Dealer

**Key**                      standard                      ○ option

<b>L</b> Seat width	<input type="checkbox"/> 34 <input type="checkbox"/> 36 <input type="checkbox"/> 38 <input type="checkbox"/> 40 <input type="checkbox"/> 42 <input type="checkbox"/> 44
<b>P</b> Seat depth	<input type="checkbox"/> 36 <input type="checkbox"/> 38 <input checked="" type="checkbox"/> 40 <input type="checkbox"/> 42 <input type="checkbox"/> 44
<b>HS</b> Back-rest height	<input type="checkbox"/> 27 <input type="checkbox"/> 29 <input type="checkbox"/> 31 <input type="checkbox"/> 33 <input type="checkbox"/> 35 <input type="checkbox"/> 37 <input type="checkbox"/> 39
<b>HA</b> Front seat/floor height	<input type="checkbox"/> 46 <input type="checkbox"/> 48 <input type="checkbox"/> 50
<b>HP</b> Rear seat/floor height	<input type="checkbox"/> 40 <input type="checkbox"/> 42 <input type="checkbox"/> 44 <input type="checkbox"/> 46
<b>DP</b> Foot-rest/seat distance	<input type="checkbox"/> 35 <input type="checkbox"/> 37 <input type="checkbox"/> 39 <input type="checkbox"/> 41 <input type="checkbox"/> 43 <input type="checkbox"/> 45 <input type="checkbox"/> 47 <input type="checkbox"/> 49 <span style="float: right;">cm</span>

# ZODIAC

Aluminium rigid frame

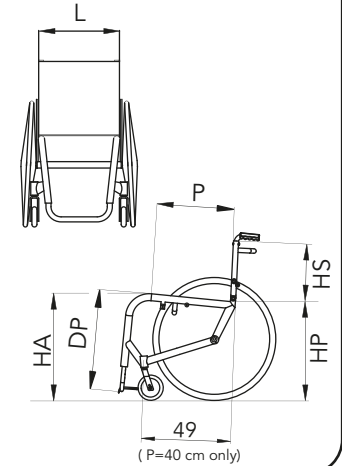

**Frame colour** ①

- Metallic grey                       Pearl white
- Glossy black                       Matte black
- ..... (see "Colours" catalogue) from:
- Neon green                       Neon orange

**Upholstery** ②

- Tension adjustable nylon back-rest
- Tension adj. breathable back-rest
- Without any back-rest upholstery
- SAMEKH**
- other seating system:.....

**Single tubular foot-plate** ③

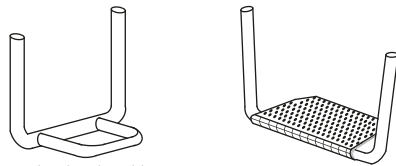

(not height adjustable)

- Open                       Closed

**Push handles** ④

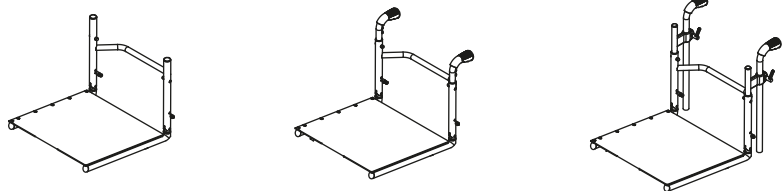

- Without pushing handles                       Standard pushing handles                       Height adjustable pushing handles

**Distance between the hub centre and back-rest** ⑤

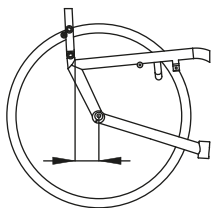

- 7 cm                       13 cm
- 9 cm (standard)                       15 cm
- 11 cm

**Back-rest tilt** ⑥

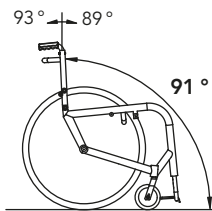

- 89°
- 91° (standard)
- 93°

**Front angle** ⑦

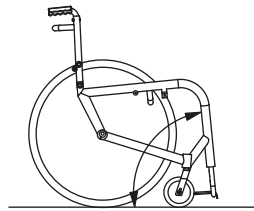

- 83° (standard) (A=16cm)
- 75° (A=23cm)

**Rear wheel camber** ⑧

- 1°     2°     3°     4°

- Quick release axles Ø12mm with 42 cambered bushes (default)
- Q.r.a. Ø 1/2" (12,7 mm) w/42 camb.bushes
- Q.r.a. Ø 1/2" (12,7 mm) w/50 camb.bushes

**Side-guards** ⑨



- Aluminium with carbon fibre wing
- Aluminium straight
- Aluminium with carbon fibre wing - detachable

**"L" arm-rest, detachable, h 22cm** ⑩

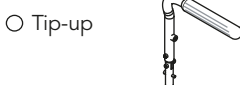

- Tip-up

**Elbow-rest**

- Tubular
- Straight (26 cm long)
- Classic (23 cm long)
- Classic (30 cm long)

**Brakes** ⑪

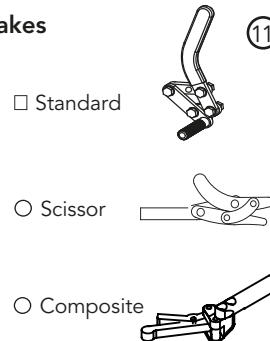

- Standard
- Scissor
- Composite

**Revolving anti-tip device** ⑫

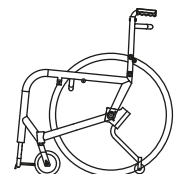

- Right
- Left

Notes

